

evolution

by BROSELEY



multifuel, woodburning, gas & electric stoves



Better make it Broseley

Broseley is named after the village in the heart of England where the family business was born nearly fifty years ago. Nearby the 18th century ironmasters forged the Industrial Revolution – a fitting origin for a company that uses traditional skills to build stoves in stout cast iron and sturdy steel to stand the test of time.

They also withstand the scientific tests required to meet the highest national and European standards of quality, safety and environmental performance. Our technical team also strives to balance innovation with craftsmanship.

Evolution is our range of stoves which can only be purchased at the showrooms of Broseley appointed stockists, not directly from the internet. Evolution is exclusive, and expanding. From the original collection of woodburning stoves, we now manufacture multifuel, gas and electric stoves, most of which are manufactured in our factories in the UK.

What all of our stoves share is quality of build and a level of efficiency over three times greater than an open fire. Balancing technical excellence with traditional skills is a delicate business. With the Evolution collection, Broseley have achieved this beautifully.

Introducing the Evolution collection

Multifuel Stoves

PAGE 6 - 17

With one of the highest efficiencies achieved in Europe and amongst the leaders for popularity, these sleek, impressive stoves can be free standing or situated within a fireplace.

For a greater presence and convenience, there are also log store versions.



Woodburning Stove

PAGE 18

Our woodburning stove caters for well seasoned wood; operation is simple and the efficiency is unrivalled.

Using the latest technology to direct different airflows around the interior you won't need to clean the glass yourself.



Boiler Stove

PAGE 19

The striking curves of this free standing stove are made possible by clever design and engineering from a combination of cast iron and steel.

It's imposing presence can make a major contribution to the central heating system of a large house.



Natural Gas & LPG Stoves

PAGE 20 - 27

A gas engine boasts such neatness and efficiency, it could be the solution you've been seeking. The comparable heat quality is remarkably reminiscent of our multifuel models but with added convenience of easy use controls for optimum output.



Electric Stoves / Inset Electric Stoves

PAGE 28 - 29

What sets these electric stoves apart are their innovative design and authenticity of visual effect. The flame's shimmer and smoulder detail is perfectly emulated with lighting technology.

1kW or 2kW of heat output will provide lasting comfort.



Picture a glorious Evolution stove in your lifestyle

Imagine settling down in a cosy room transformed by an Evolution stove from Broseley. What would you love the most? The sight of lazily dancing flames and shimmering embers?

Or the soft, natural warmth flowing not from radiators but a real fire handsomely contained?

At Broseley, we believe the visual appeal is inseparable from the sensation. That's why Evolution's designers have created Actiview™ technology. The flow of hot air keeps the window clean and clear.

So you miss nothing of the view within as it changes from blazing drama to smouldering slumber throughout yet another blissful evening.



Evolution and the environment



Smoke exempt

What's better for home life is good for the planet too. Wood is not only a renewable source of energy, it's also carbon neutral. That's because during its lifetime a growing tree absorbs as much, if not more carbon dioxide than it emits when it burns or decays.

Using your stove to burn wood reduces the need for central heating which consumes non-renewable fossil fuels. As well as the comfort of knowing you're making a small, positive contribution to the environment for future generations, you can pat yourself on the back for offsetting the ever rising energy costs today.

Those of us who live in towns and cities dwell in smoke control areas as defined by the Clean Air Act.

Here you are permitted only to burn smokeless fuel or use woodburning appliances which have passed the emissions tests set by the Department of Environment Food and Rural Affairs (DEFRA).

So efficiently do Evolution stoves convert wood to heat, they bear the Smoke Exempt seal.



ActiView
TECHNOLOGY

Introducing ActiView™

People are rightly attracted to install a stove because it makes such a visible difference to a room. But remember, burning fuel creates deposits. These can settle on the glass front and obscure the view.

You can mitigate the effect by choosing kiln dried logs with low moisture content, but Evolution's new ActiView™ system goes further. It enables the stove itself to keep its own glass clean for longer.

Like all fires, a stove needs an airflow to ignite the fuel and keep it burning. The difference with an Evolution stove is that a system of hidden ducts and channels directs three types of airflow into the fire.

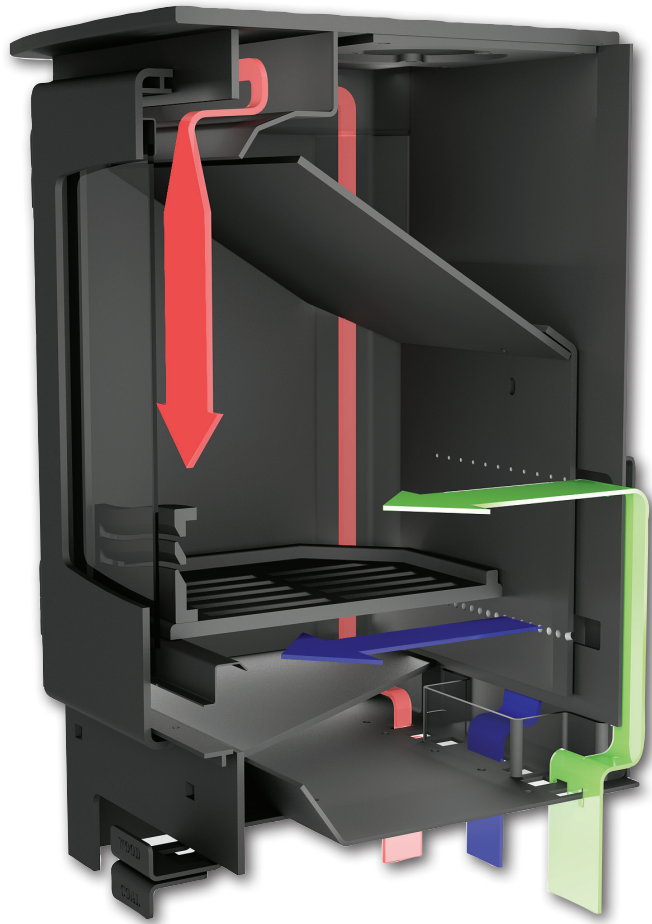

Primary Flow

Smokeless fuels require an airflow beneath the coals which enters via the primary air intake. As well as keeping non-wood fires burning brightly, the primary flow is also used to get a log fire started.

Secondary Flow

A secondary intake introduces an airflow into channels around the back and top of the stove where it warms up and circulates down the surface of glass - the ActiView™ system.

This current of pre-heated air prevents smoke from coming into contact with the glass, maintaining a clear view of the fire. As the air continues to circulate across the burning wood, it combusts unburned volatile gasses for a cleaner burn.

Tertiary Flow

The latest Evolution models have a series of air holes punched into the back of the fire box. This allows small jets of air to pass through and ignite, sending spurts of flame into the heart of the fire to boost combustion.



You can regulate the rate of burn by using the simple slide controls. One opens and closes the primary air intake, the other regulates the secondary air intake.

Evolution 5

MULTIFUEL STOVE



Witness how a multifuel stove in the sleek shape of the Evolution 5 can create a revolution in the way your room looks and feels.

Sitting within the hearth space, the Evolution 5 agreeably complements the contemporary design of the room, whilst adding the timeless touch of a real fire spreading its glow through the satisfyingly large viewing window.

As for warmth, the Evolution 5 has an output of 5kW, enough to heat a medium sized room. Its exceptional efficiency rating of 80.5% makes it one of the most efficient multifuel stoves you can buy.



Evolution 5 with log store

Evolution 5

Dimensions	W: 450mm x H: 583mm x D: 434mm
Flue Diameter	150mm
Heat Output	5kW: Wood
Efficiency	80.5%
Flue Outlet	Top and rear

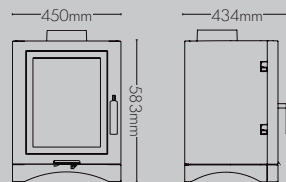

Evolution 5 with log store

Dimensions	W: 450mm x H: 923mm x D: 434mm
Flue Diameter	150mm
Heat Output	5kW: Wood
Efficiency	80.5%
Flue Outlet	Top and rear

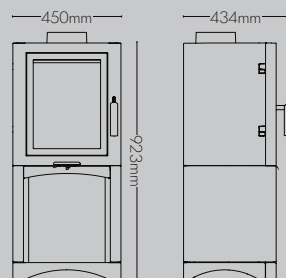



Evolution 5 shown with the Elgin & Hall Colwyn Limestone inglenook surround



Evolution 5 Deluxe with log store



Evolution 5 Deluxe

MULTIFUEL STOVE



The difference with the Evolution 5 Deluxe multifuel stove is a distinctive and stylish feature - a glass top. Its smooth reflective surface provides a subtle but satisfying contrast with the Metallic Black finish of the cast iron body, an added design element that will draw the warmest compliments from your guests.

This model is also available with a convenient log store.



Evolution 5 Deluxe

Evolution 5 Deluxe

Dimensions	W: 450mm x H: 583mm x D: 434mm
Flue Diameter	150mm
Heat Output	5kW: Wood
Efficiency	80.5%
Flue Outlet	Top and rear

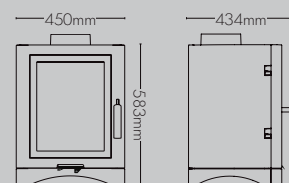

Evolution 5 Deluxe with log store

Dimensions	W: 450mm x H: 923mm x D: 434mm
Flue Diameter	150mm
Heat Output	5kW: Wood
Efficiency	80.5%
Flue Outlet	Top and rear

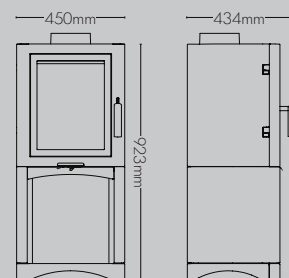



Ignite 5 with log store

Ignite 5

MULTIFUEL STOVE



Built from steel in Britain, the adaptable Ignite range has a cast iron door with a Matt Black finish and a soft curve to the base. This touch of elegance enables it to make itself at home anywhere from a minimalist town house interior to a cottage parlour.

The log store adds the convenience of not having to fetch fuel from outside. A grill beneath the stove helps keep the wood dry for optimum burning. The heat output of this multifuel stove is 5kW and its efficiency is exceptional at a maximum of 82.9%.

Enjoy the Ignite's good looks and high efficiency for rooms where there is no space or preference for a log store.

IGNITE GAS

The Ignite 5 multifuel stove is also available as a Gas stove option.

See page 22



Ignite 5

Ignite 5

Dimensions	W: 430mm x H: 582mm x D: 353mm
Flue Diameter	125mm
Heat Output	5kW: Wood
Efficiency	82.9%
Flue Outlet	Top and rear

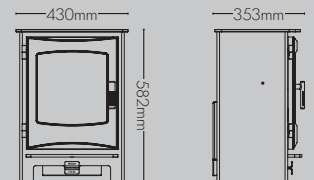

Ignite 5 with log store

Dimensions	W: 430mm x H: 827mm x D: 353mm
Flue Diameter	125mm
Heat Output	5kW: Wood
Efficiency	82.9%
Flue Outlet	Top and rear

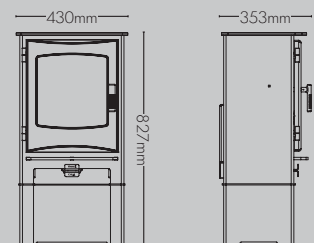

Ignite 7

MULTIFUEL STOVE



ActiView
TECHNOLOGY



This broad and handsome multifuel stove has a 7kW heating capacity to keep a good sized room cosy. The door is Matt Black finished cast iron, enabling our designers to add a curved flourish to enhance the stove's presence in any situation, modern or traditional.

The cast door is softly arched and the grate front is wave-shaped, adding to the enjoyment of the ActiView™ clean panorama of flames. With a choice of top or rear flue outlet, you can position the stove inside an existing hearth or freestanding against an external wall.

IGNITE GAS

The Ignite 7 multifuel stove is also available as a Gas stove option.

See page 22



Ignite 7 with log store

Ignite 7

Dimensions	W: 542mm x H: 582mm x D: 351.5mm
Flue Diameter	125mm
Heat Output	7kW: Wood
Efficiency	79.4%
Flue Outlet	Top and rear

Ignite 7 with log store

Dimensions	W: 542mm x H: 827mm x D: 351.5mm
Flue Diameter	125mm
Heat Output	7kW: Wood
Efficiency	79.4%
Flue Outlet	Top and rear

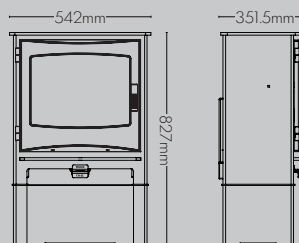
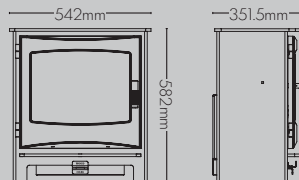



Ignite 7



Desire 5 with log store

Desire 5

MULTIFUEL STOVE



ActiView
TECHNOLOGY



This British built newcomer is simplicity itself. Its primary and secondary air controls make it easy to regulate, and ActiView™ technology keeps the glass clean. The 5kW output is ideal for a small to medium sized room, and fuel efficiency is exceptional at up to 82.9%. An optional air intake directs air from outside directly into the stove's combustion chamber, an advantage in draught-free, well-sealed modern houses.

All the features of Desire 5 are available with the extra convenience and visual appeal of an integral log store.

DESIRE GAS & ELECTRIC

The Desire 5 multifuel stove is also available as a Gas and Electric stove option.

For Gas see page 23
For Electric see page 24



Desire 5

Desire 5

Dimensions	W: 430mm x H: 582mm x D: 353mm
Flue Diameter	125mm
Heat Output	5kW: Wood
Efficiency	82.9%
Flue Outlet	Top and rear

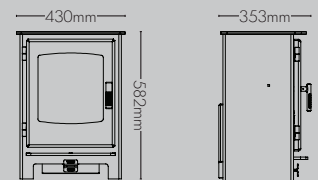

Desire 5 with log store

Dimensions	W: 430mm x H: 827mm x D: 353mm
Flue Diameter	125mm
Heat Output	5kW: Wood
Efficiency	82.9%
Flue Outlet	Top and rear

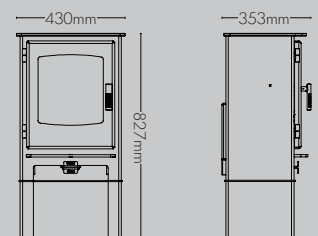

Desire 7

MULTIFUEL STOVE



ActiView
TECHNOLOGY



With a 7kW output this British built stove has ample capacity to heat a medium to large sized room. With its integral log store it will certainly make its presence felt. The log store raises the stove so you can enjoy the dancing flames at eye level when you're sitting down. The pattern of cut log ends stacked together adds an extra naturalistic touch to your room design. Like the smaller Desire 5, it has an external combustion air intake option for homes with no inside draught to encourage the fire.

You can also enjoy full 7kW power and efficiency for rooms where there is no space for a log store.

DESIRE GAS & ELECTRIC

The Desire 7 multifuel stove is also available as a Gas and Electric stove option.

For Gas see page 23
For Electric see page 24



Desire 7

Desire 7

Dimensions	W: 542mm x H: 582mm x D: 351.5mm
Flue Diameter	125mm
Heat Output	7kW: Wood
Efficiency	79.4%
Flue Outlet	Top and rear

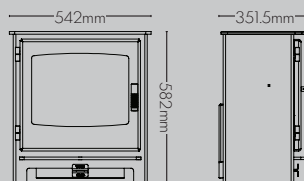

Desire 7 with log store

Dimensions	W: 542mm x H: 827mm x D: 351.5mm
Flue Diameter	125mm
Heat Output	7kW: Wood
Efficiency	79.4%
Flue Outlet	Top and rear

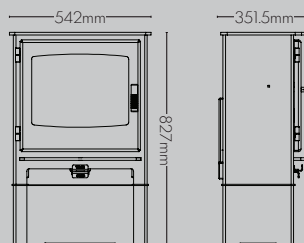

Desire 7 with log store



Flair 8

WOODBURNING STOVE

This all-steel stove is designed for all-round impact. In Metallic Black finish with Chrome handle and portrait shaped large viewing window, it provides a contemporary twist to the woodburning tradition. With curved contours it can radiate a powerful 8kW worth of heat quickly throughout a large room or open plan ground floor. Its open fronted integral log store completes the designer interior look with patterns made by variegated cut log ends; or choose the log store with door option for a sleek look.

Although it's a woodburner, it has two air controls – primary to help it light, secondary to keep it blazing.



Width	602mm
Height	1159mm
Depth	447mm
Flue Diameter	150mm
Heat Output	8kW
Efficiency	80%
Flue Outlet	Top

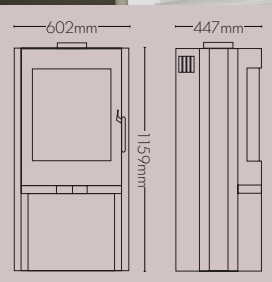

Flair 8 with door

Evolution 26

WOODBURNING BOILER STOVE



This woodburning stove is the most powerful in the Evolution range. Its greater width gives your household a magnificent blazing expanse of flames within an open fireplace. It will throw out up to 10.1kW of heat directly, enough for a considerably sized room. Its indirect effect is remarkable too, contributing a full 15.8kW to a central heating system.

Benefits of a Boiler stove

When you choose an Evolution boiler stove it will help heat radiators and water throughout the house, saving money and the environment. This boiler stove can be easily integrated with either the unvented (combi boiler) system or the traditional vented system with water tanks.

For more information on boiler stoves, visit www.broseleyfires.com



Width	800mm
Height	700mm
Depth	718mm
Flue Diameter	150mm
Heat Output	10.1kW room/15.8kW water
Efficiency	77.9%
Flue Outlet	Top

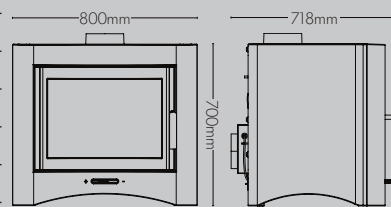

Evolution 26

Evolution 5 & Evolution 5 Deluxe Gas

GAS STOVE

The Evolution 5 gas stove boasts contemporary style to suit any home and offers 4.6kW in warmth to comfortably heat a medium sized room. Watch the flicker of the realistic flame pattern through the generous viewing window and admire the comforting warmth as it reaches the furthest corners of your room.

The striking glass top of the Evolution 5 Deluxe adds a charming characteristic which stands out against the Metallic Black finish of the cast iron body.



Evolution 5 gas

The beauty of a gas stove

There's nothing quite like the glow of a gas stove. From hand crafted ceramic fibre logs, the flame picture is remarkably reminiscent of the real thing. The heat is comparable in quality to the warmth radiating from our equivalent multifuel models. Although the heat output is slightly less, the extra convenience of gas more than compensates.



Evolution 5 & 5 Deluxe gas stoves are available with a remote control to allow for effortless operation. With the ease of adjusting the heat and flame options you can enjoy the comfort of this glorious gas stove at the touch of a button.

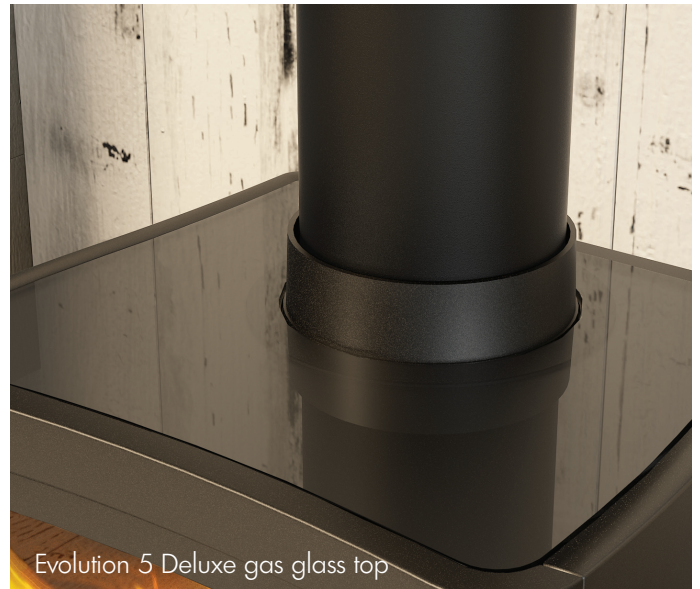

Evolution 5 Deluxe gas glass top



Evolution 5 & 5 Deluxe gas control

For convenient control, the simple push-pull operation provides easy ignition of the pilot light and simple regulation of the gas flame.

Width	452mm
Height	583mm
Depth	438mm
Flue Diameter	125mm
Heat Output	4.6kW (top)
Efficiency	82%
Flue Outlet	Top and rear
Remote Control	Optional

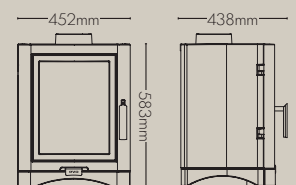

Ignite 5 & 7 Gas

GAS STOVE

Built from steel with a Matt Black finish cast iron door, the Ignite gas stoves are striking additions to the Evolution range. With a large panoramic window and realistic log bed, your room will be brought to life by the mesmerising flames. The Ignite provides a generous heat output, encompassing the whole room with warmth.



Ignite 7 gas

Ignite 5 gas - remote control option available

Width	430mm
Height	582mm
Depth	366.5mm
Flue Diameter	125mm
Heat Output	4.6kW (top)
Efficiency	80%
Flue Outlet	Top and rear
Remote Control	Optional

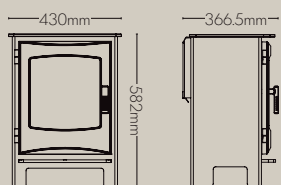

Ignite 7 gas

Width	542mm
Height	582mm
Depth	362mm
Flue Diameter	125mm
Heat Output	4.7kW (top)
Efficiency	76%
Flue Outlet	Top
Remote Control	No

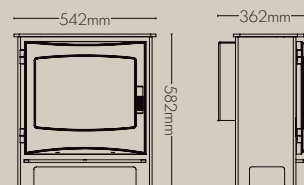

Desire 5 & 7 Gas

GAS STOVE

The Desire gas stoves are distinctive by their large glass windows that perfectly frame the dancing flames within.

Built from steel, the Desire has a smooth Matt Black finish with a stylish and realistic log bed. With impressive efficiencies you can control the heat output perfectly and furthermore the effect is almost instant – all you need to do is choose which size Desire suits your fireplace and room.



Desire 5 gas shown with the Be Modern Elicott Solid Natural Oak surround

Desire 5 gas - remote control option available

Width	430mm
Height	582mm
Depth	366.5mm
Flue Diameter	125mm
Heat Output	4.6kW (top)
Efficiency	80%
Flue Outlet	Top and rear
Remote Control	Optional

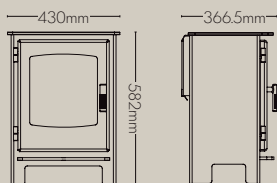

Desire 7 gas

Width	542mm
Height	582mm
Depth	362mm
Flue Diameter	125mm
Heat Output	4.7kW (top)
Efficiency	76%
Flue Outlet	Top
Remote Control	No

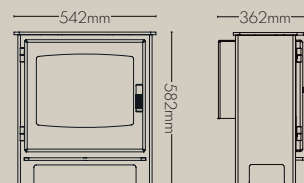

Ignite LPG

LPG STOVE

The Ignite LPG allows the same stunning look of the Ignite family of stoves, but with the convenience of a clean, efficient energy. The steel body with cast iron door and Matt Black finish creates a unique contemporary feel, whilst the generous 3.5kW heat output and exceptional 77% efficiency ensure your home is comfortable and inviting even during those chilly Autumnal evenings.



Width	430mm
Height	582mm
Depth	366.5mm
Flue Diameter	125mm
Heat Output	3.5kW (top)
Efficiency	77%
Flue Outlet	Top and rear
Remote Control	No

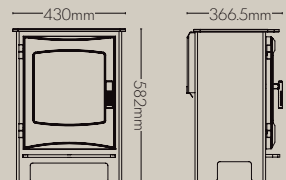

Ignite LPG shown with the Elgin & Hall Odella micro marble inglenook surround

Desire LPG

LPG STOVE

Keeping the distinctive design of the Desire family of stoves, the Desire LPG offers flexibility in heating your home. The intricate log bed adds a stylish charm and the large viewing window allows the realistic flame effect to be enjoyed from afar. Furthermore, you can bask in the 3.5kW heat output that will gladly fill the space in which the stove sits.



Width	430mm
Height	582mm
Depth	366.5mm
Flue Diameter	125mm
Heat Output	3.5kW (top)
Efficiency	77%
Flue Outlet	Top and rear
Remote Control	No

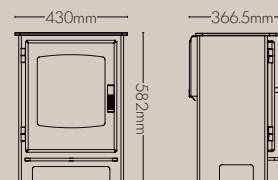

Desire 5 LPG

Endure

BALANCED FLUE GAS STOVE

The British built Endure Balanced Flue gas stove is a sleek and stylish addition to the Evolution range.

Enjoy the enviable 3.3kW heat output and admire the realistic flame effect which will playfully flicker in full view through the large window. The Matt Black finish adds to the contemporary flourish that the Endure exudes. Should you wish to, there is the option to add a false top flue spigot for an adaptable look.

With an impressive efficiency rating of 86%, the Endure is one of the most efficient gas stoves you can buy. Install directly against an external wall and enjoy the ambience of the glowing flames.



Width	542mm
Height	622mm
Depth	336mm
Flue Diameter	125mm
Heat Output	3.3kW
Efficiency	86%
Flue Outlet	Rear
Remote Control	No

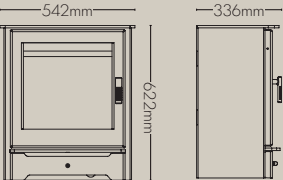

Versatile Balanced Flue

The flicker of the realistic gas flame can be enjoyed even in those situations where you have no chimney or flue. Our Balanced Flue stove is perfect for venting directly through an outside wall.

Identified by a round flue installed directly through an external wall, our Balanced Flue stove is fitted

against a flat wall and completely sealed from the front, allowing air to circulate through flue to the rear of the stove. Cold air is sucked into the fire to combust and the gases are expelled at the same point.

Our Balanced Flue stove is highly efficient and can be installed without a chimney.



Endure Balanced Flue

Desire 5, 6 & 7

ELECTRIC STOVE

Our Desire electric stoves provide the shimmer and smoulder of a woodburning stove but in the most convenient form. This steel construction in Matt Black finish is available in three sizes, each providing up to 2kW heat output and thermostat controls.

With a large panoramic window, the realistic flame effect can be enjoyed with or without heat any time of the year.

The convenience of an electric stove

With an electric stove there's no need for a flue. You can safely sit a stove directly on to a level surface such as a wooden floor; the only installation required is plugging into a socket. It will convect 1kW or 2kW of heat into the room, thermostatically controlled for lasting comfort.



Desire 5 electric stove with the Elgin & Hall Eternia micro marble inglenook surround

Desire 5 electric

Dimensions (mm)	W: 430 x H: 587 x D: 292
Heat Output	2kW
Efficiency	100%
Remote Control	Yes

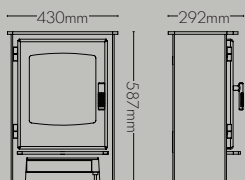

Desire 6 electric

Dimensions (mm)	W: 486 x H: 587 x D: 292
Heat Output	2kW
Efficiency	100%
Remote Control	Yes

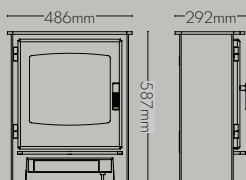

Desire 7 electric

Dimensions (mm)	W: 542 x H: 587 x D: 292
Heat Output	2kW
Efficiency	100%
Remote Control	Yes

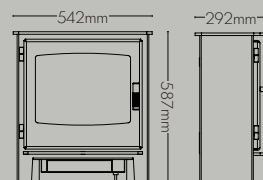

Desire

INSET ELECTRIC STOVE

With a stylish Matt Black finish, the steel construction of the Desire inset electric stove is sure to add character to your room. The curved window allows you to witness the enticing glow any time of the year with a flame effect only setting. Install within an existing fireplace or pair with a 75mm rebate surround to get the perfect flat wall fit.

Width	486mm
Height	587mm
Depth	237.5mm
Heat Output	2kW
Efficiency	100%
Remote Control	Yes

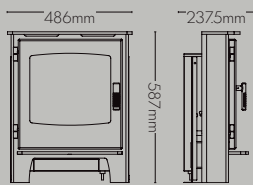

Desire inset electric stove shown with the Elgin & Hall Viena micro marble surround



Ignite inset electric stove shown with the Elgin & Hall Vamella micro marble surround

Ignite

INSET ELECTRIC STOVE

The real cast iron door of the Ignite inset electric stove gives an authentic look of a genuine multifuel stove. Enjoy the shimmering glow of the realistic coal bed with a warming 2kW heat or use the flame effect only setting on those warmer nights. It can be installed into an existing fireplace or a 75mm rebate surround for a flat wall fit.

Width	486mm
Height	587mm
Depth	237.5mm
Heat Output	2kW
Efficiency	100%
Remote Control	Yes

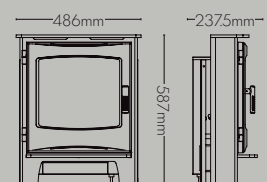

Dimensions

The Evolution collection provides a choice of highly efficient multifuel, woodburning, gas and electric stoves, in such a range of sizes, there is a model to suit every home.

The dimensions given in this table provide you with a good starting point to assess how well they might fit into the room you have in mind.



Having viewed the most promising candidates in the showroom, ask the advice of the Evolution appointed stockist about its suitability. For a precise picture, you can arrange a survey with a HETAS approved engineer.

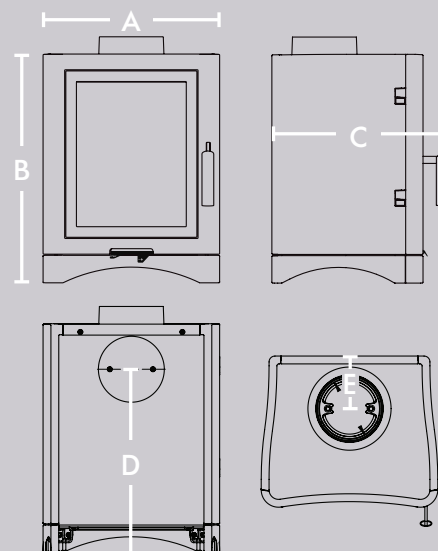

Model	Fuel Type	Width (A)	Height (B)	Depth (C)	Flue Diameter	To centre of rear flue (D)	To centre of top flue (E)	Nominal Heat Output	Efficiency
Desire 5	Multifuel	430	582	353	125	470	115	5kW: Wood	82.9% Wood
Desire 5 with log store	Multifuel	430	827	353	125	715	115	5kW: Wood	82.9% Wood
Desire 7	Multifuel	542	582	351.5	125	470	115	7kW: Wood	79.4% Wood
Desire 7 with log store	Multifuel	542	827	351.5	125	715	115	7kW: Wood	79.4% Wood
Evolution 5	Multifuel	450	583	434	150	467	134	5kW: Wood	80.5% Wood
Evolution 5 with log store	Multifuel	450	923	434	150	807	134	5kW: Wood	80.5% Wood
Evolution 5 Deluxe	Multifuel	450	583	434	150	467	134	5kW: Wood	80.5% Wood
Evolution 5 Deluxe log store	Multifuel	450	923	434	150	807	134	5kW: Wood	80.5% Wood
Ignite 5	Multifuel	430	582	353	125	470	115	5kW: Wood	82.9% Wood
Ignite 5 with log store	Multifuel	430	827	353	125	715	115	5kW: Wood	82.9% Wood
Ignite 7	Multifuel	542	582	351.5	125	470	115	7kW: Wood	79.4% Wood
Ignite 7 with log store	Multifuel	542	827	351.5	125	715	115	7kW: Wood	79.4% Wood
Flair 8 with log store	Woodburning	602	1159	447	150	N/A	224	8kW	80%
Flair 8 with door	Woodburning	602	1159	447	150	N/A	224	8kW	80%
Evolution 26 Boiler	Woodburning	800	700	718	150	N/A	250	10.1kW: Room / 15.8kW: Water	77.9%
Desire Gas 5	Gas	430	582	366.5	125	480	130	6.4kW Input / 4.6kW Output	80%
Desire Gas 7	Gas	542	582	362	125	N/A	162	6.8kW Input / 4.7kW Output	76%
Desire LPG	LPG	430	582	366.5	125	480	130	5kW Input / 3.5kW Output	77%
Endure Balanced Flue	Gas	542	622	336	125	418	123*	4.2kW Input / 3.3kW Output	86%
Evolution 5 Gas	Gas	452	583	438	125	467	134	6.2kW Input / 4.6kW Output	82%
Evolution 5 Deluxe Gas	Gas	452	583	438	125	467	134	6.2kW Input / 4.6kW Output	82%
Ignite Gas 5	Gas	430	582	366.5	125	480	130	6.4kW Input / 4.6kW Output	80%
Ignite Gas 7	Gas	542	582	362	125	N/A	162	6.8kW Input / 4.7kW Output	76%
Ignite LPG	LPG	430	582	366.5	125	480	130	5kW Input / 3.5kW Output	77%
Desire 5 Electric	Electric	430	587	292	125	N/A	105*	1kW / 2kW	100%
Desire 6 Electric	Electric	486	587	292	125	N/A	105*	1kW / 2kW	100%
Desire 7 Electric	Electric	542	587	292	125	N/A	105*	1kW / 2kW	100%
Desire Inset Electric	Electric	486	587	237.5	N/A	N/A	N/A	1kW / 2kW	100%
Ignite Inset Electric	Electric	486	587	237.5	N/A	N/A	N/A	1kW / 2kW	100%



All Evolution multifuel and woodburning stoves are smoke exempt except the Flair 8. External air intake option available on all Ignite, Desire and Boiler Stove models.

* For use when a false flue spigot is fitted

All dimensions shown in mm

For full product specifications please visit www.broseleyfires.com



Evolution 5 Deluxe shown with the Elgin & Hall Colwyn Limestone inglenook surround

Stove Installation

All woodburning, multifuel and boiler stoves must be installed and commissioned by HETAS registered heating engineers or a competent person registered with the Government approved competent persons scheme. A site survey should be carried out prior to any appliance purchase to ensure the suitability for your property. Sealed heating system installations should only be carried out by engineers who are suitably qualified. All gas stoves must be installed and commissioned by Gas Safe engineers.

Failure to comply with these requirements will invalidate your product warranty.

WARRANTY

All Evolution multifuel and woodburning stoves come with a 5 year guarantee from the date of purchase. Gas and electric appliances carry a 12 month warranty which covers any manufacturing faults. It is important to note that a number of components in your stove are classed as consumable and therefore will need to be replaced from time to time (consumable parts include grates, firebricks and rope. This also includes bulbs in electric stoves.) Glass does not carry any form of warranty, this is because the glass can only break through mechanical impact.



Your **Evolution** retailer is:



Multifuel



Gas



Electric

BROSELEY

Broseley Fires Limited

First Floor, Unit B Knights Court, Archers Way
Battlefield Enterprise Park, Shrewsbury, SY1 3GA

Telephone: 01743 461444 | **Fax:** 01743 461446 | **Email:** sales@broseleyfires.com

www.broseleyfires.com

Join our
social network



evolution
by **BROSELEY**

multifuel, woodburning, gas & electric stoves